

Glamour, modern *seduction.*

design Dodo Arslan
terzani.com

TERZANI
LA LUCE PENSATA





Name
Glamour
chandelier

Materials
metal



Finishes | Code

-  white
ON16S E8 C8
-  nickel plated
ON16S E7 C8
-  gold plated
ON16S L6 C8

Body

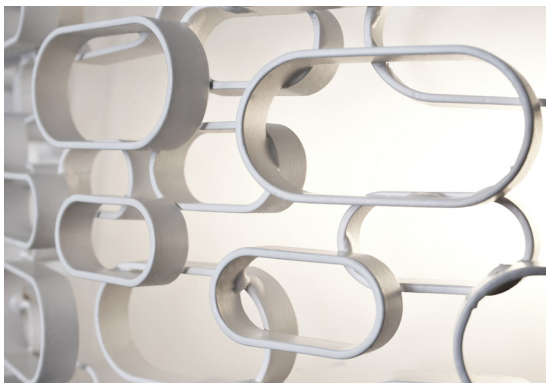
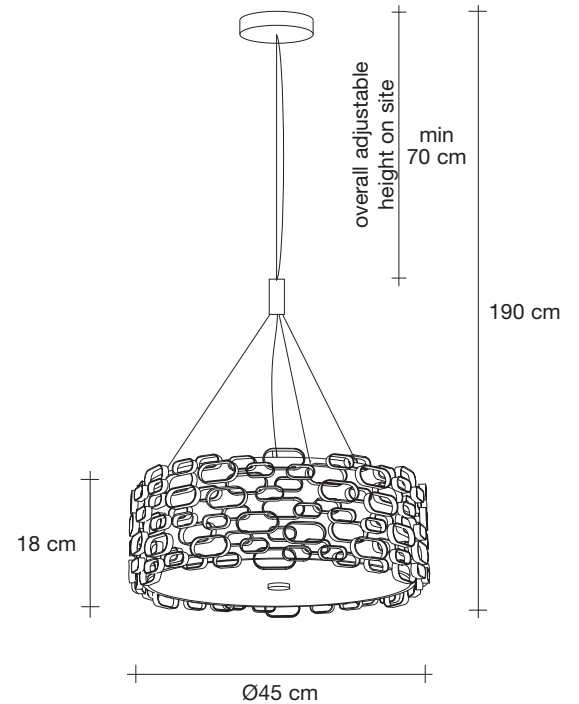

Light source
230-240V ~ 50/60Hz

 LED
3 x 4W E14 dimmable

dimming options

 all systems

Canopy

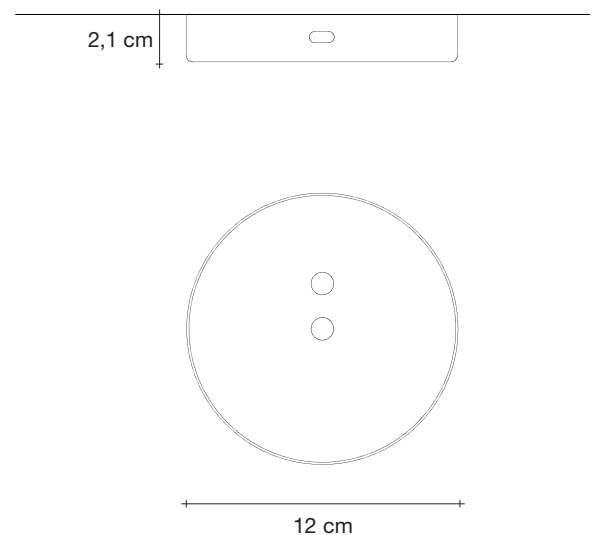

Glamour's randomly interspersed rings imbue this design with a seductiveness rarely applied to geometric shapes. Whether finished in gold, nickel or white, the diffused light emanating behind Glamour's rings bathes the surrounding area in a soft, sensuous glow. Available as a wall sconce, table lamp or pendant, Glamour can provide subtle accents or act as the focal point of a room. Available in nickel, gold plated and white finishes. Design Dodo Arslan. Made in Italy.

Glamour, modern *seduction.*

design Dodo Arslan
terzani.com

TERZANI
LA LUCE PENSATA

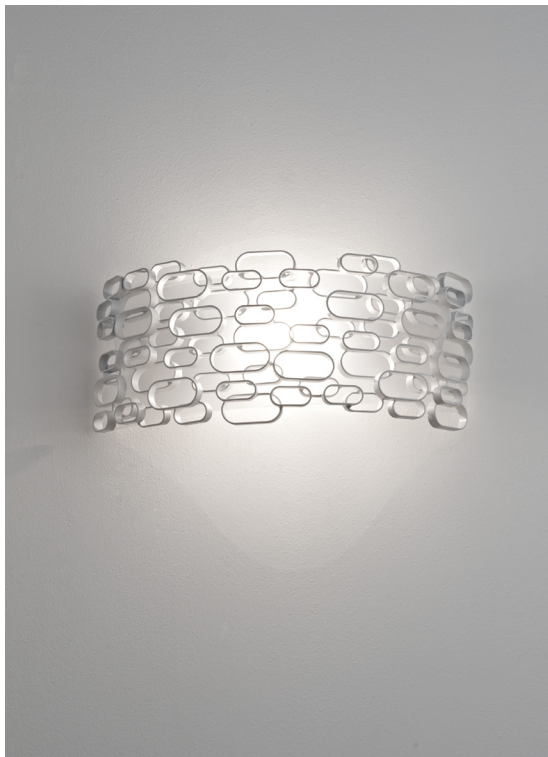



Name
Glamour
wall sconce

Materials
metal



Finishes | Code

-  white
ON18A E8 C8
-  nickel plated
ON18A E7 C8
-  gold plated
ON18A L6 C8

Body

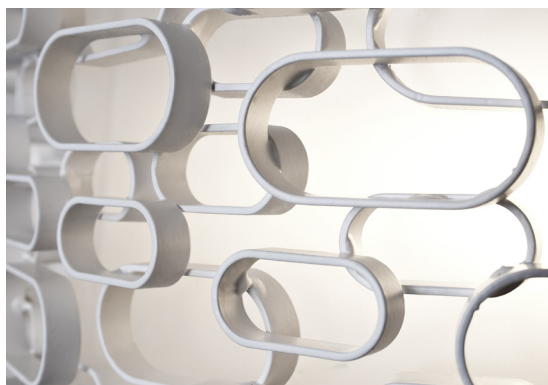
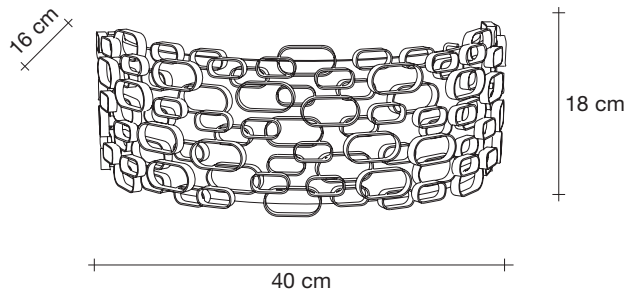

Light source options

230-240V ~ 50/60Hz

 HALOGEN
48W R7s

or

 LED integrated
13W 1025 lm
3000K

dimnable options

 all systems
IGBT

Glamour's randomly interspersed rings imbue this design with a seductiveness rarely applied to geometric shapes. Whether finished in gold, nickel or white, the diffused light emanating behind Glamour's rings bathes the surrounding area in a soft, sensuous glow. Available as a wall sconce, table lamp or pendant, Glamour can provide subtle accents or act as the focal point of a room. Available in nickel, gold plated and white finishes. Design Dodo Arslan. Made in Italy.

Glamour, modern *seduction.*

design Dodo Arslan
terzani.com

TERZANI
LA LUCE PENSATA





Name
Glamour
ceiling light

Materials
metal



Finishes | Code

-  white
ON17L E8 C8
-  nickel plated
ON17L E7 C8
-  gold plated
ON17L L6 C8

Body

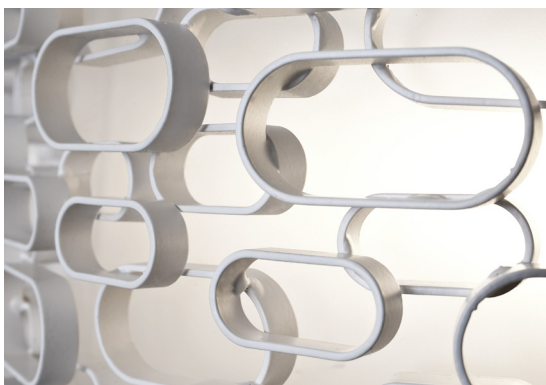
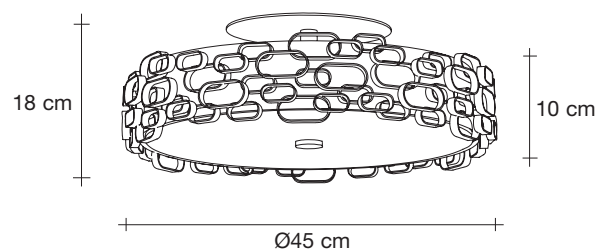

Light source
230-240V ~ 50/60Hz

 LED
3 x 4W E14 dimmable

dimmable options

 all systems

Canopy

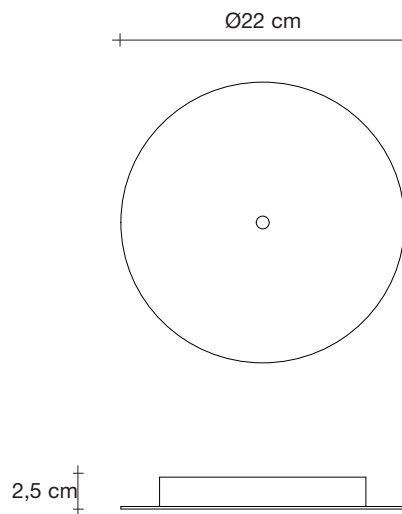

Glamour's randomly interspersed rings imbue this design with a seductiveness rarely applied to geometric shapes. Whether finished in gold, nickel or white, the diffused light emanating behind Glamour's rings bathes the surrounding area in a soft, sensuous glow. Available as a wall sconce, table lamp or pendant, Glamour can provide subtle accents or act as the focal point of a room. Available in nickel, gold plated and white finishes. Design Dodo Arslan. Made in Italy.